

HG/HF 20 - 30



20/30 litros hora

# Gama 30 TOP

Agua fría, ambiente, gas.

Equipos para oficinas,  
bares, cafeterías y  
pequeño restaurante.

Dispensador de sobremesa.  
Acero-ABS con frontal de  
cristal.

30 lph  
Producción  
agua fría



Cabinet  
opcional



## CARACTERÍSTICAS:





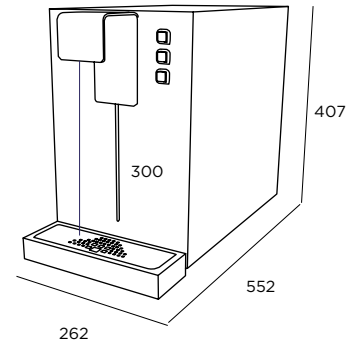

Producción: 30 l/h.  
Producción continua: 7 l.  
Temperatura: 3 - 10 °C.  
Capacidad del banco del hielo: 2 kg.  
Gas refrigerante: R290.  
Potencia del compresor: 1/10 CV.  
Salidas de agua: 1.  
Conexión entrada agua: 8 mm.  
\*Conexión entrada gas: 6 mm.  
Materiales de fabricación: Acero y ABS.  
Peso: 23-28 Kg (según modelo).

\*Solo modelos HG  
(Ver Cabinets en páginas 112-113)

## ACCESORIOS:

Adaptador H3/4" - Espiga 8 mm.  
Codo unión 8 mm.  
Adaptador M3/8" - 8 mm.  
1 m tubo 8 mm.  
\*1 m tubo 6 mm.  
\*Reductor presión CO<sub>2</sub>.



								Tarifa
	Ambiente	Fría	Gas	Regulación de volumen	Electrónica	Mecánica	Touchless	
980314 HG 30 E TOP	•	•	•	•	•			H
980287 HG 30 TOP	•	•	•			•		H
980550 HF 30 E TOP	•	•		•	•			H
980313 HF 30 TOP	•	•				•		H
980628 HG 30 E TOP TOUCHLESS	•	•	•	•	•		•	H
980854 HF 30 E TOP TOUCHLESS	•	•		•	•		•	H